

# INSTRUCTION MANUAL

**DRAKE**

MODEL

# MN-2000

## Antenna Matching Network

2000 WATTS P.E.P.



Price of Manual

\$2.00

## STANDARD WARRANTY

R. L. Drake Company warrants each new radio product manufactured by it to be free from defective material and workmanship and agrees to remedy any such defect or to furnish a new part in exchange for any part of any unit of its manufacture which under normal installation, use, and service discloses such defect, provided the unit is delivered by the owner to us or to our authorized radio dealer or wholesaler from whom purchased, intact, for our examination, with all transportation charges prepaid to our factory, within ninety days from the date of sale to original purchaser and provided that such examination discloses in our judgement that it is thus defective. Should a malfunction be suspected, write in detail to our Service Department for suggestions concerning the operation, repair or return of your unit if it should prove necessary.

This warranty does not extend to any of our radio products which have been subjected to misuse, neglect, accident, incorrect wiring not our own, improper installation, or to use in violation of instructions furnished by us, nor extend to units which have been repaired or altered outside our factory, nor in cases where the serial number thereof has been removed, defaced or changed, nor to units used with accessories not manufactured or recommended by us.

Any part of a unit approved for remedy or exchange hereunder will be remedied or exchanged by the authorized radio dealer or wholesaler without charge to the owner.

This warranty is in lieu of all other warranties expressed or implied and no representative or person is authorized to assume for us any other liability in connection with the sale of our radio products.

The R. L. Drake Company reserves the right to make any improvements to its products which it may deem desirable without obligating itself to install such improvements in its previously manufactured products.

## TABLE OF CONTENTS

<u>Section</u>		<u>Page</u>
1.	Specifications	1
2.	Description	2
3.	Installation	3
4.	Operation	4

## ILLUSTRATIONS

		<u>Page</u>
80M	Curves	8
40M	Curves	9
20M	Curves	10
15M	Curves	11
10M	Curves	12
Schematic Diagram		13

MN-2000 SPECIFICATIONS

FREQUENCY COVERAGE:

3.5 to 4.0 MHz  
7.0 to 7.3 MHz  
14.0 to 14.35 MHz  
21.0 to 21.45 MHz  
28.0 to 29.7 MHz

INPUT IMPEDANCE: 50 ohms ( resistive )

LOAD IMPEDANCE: 50 ohm coax with VSWR of 5:1 or less ( any impedance angle )  
75 ohm coax at a lower VSWR can be used.

POWER CAPABILITY: 1000 watts RF average continuous Duty, 2000 watts PEP

WATTMETER ACCURACY:  $\pm$  ( 5% of reading + 2 watts ) on 200 watt scale,  $\pm$  ( 5% of reading + 20 watts ) on 2000 watt scale

INSERTION LOSS: 0.5 dB or less on each band after tuning

DIMENSIONS: 5 1/2" high, 10 3/4" wide, 14 3/8" deep ( including connectors )

Front panel controls are provided for the adjustment of resistive and reactive tuning and VSWR calibration, bandswitching, selection of watts or VSWR functions of the meter, and antenna or dummy load switching. The rear panel has four type SO-239 connectors, one for input, two for outputs to antennas, one for alternate antenna or dummy load, and a ground post. The metering circuit employs two type 1N295 rectifiers.

Frequencies outside the amateur bands can be matched, with some reduction in the impedance range. For highly resistive loads, VSWR well in excess of 5:1 can be matched.

DESCRIPTION

The typical modern transmitter has a pi-network tank circuit and will work into resistive loads of 50 to 75 ohms with Voltage Standing Wave Ratios ( VSWR ) of 2:1 or less. This resistive load can only be achieved with a resonant antenna; thus for multi-band operation multiple antennas are required. Space and cost considerations render this solution impractical for most amateurs. The MN-2000 impedance-matching network can:

1. Measure feedline VSWR, then reduce the VSWR at the transmitter output to 1:1.
2. Monitor transmitter power output in watts directly and continuously.
3. Attenuate 2nd harmonic output from transmitter by 25 to 35 dB; thus it may eliminate the need for a low-pass TVI filter.
4. Match an antenna to a transmitter having fixed loading.
5. Give optimum match with multi-band antennas.
6. Precisely match transmitter to an antenna across a complete amateur band.
7. Permit "off the air" transmitter tuning and antenna matching at low power using dummy load.
8. Eliminate reloading transmitter when switching from "barefoot" to linear amplifier operation as antenna load can always be 50 ohms.
9. Match transmitter output to linear amplifier which does not have 50 ohm input impedance.
10. Help localize trouble by comparing transmitter output into antenna and into dummy load.
11. Provide switching for up to three separate antennas or two antennas and a dummy load.
12. Can be switched in or out with front panel control.

### 3.1 UNPACKING

Carefully remove the MN-2000 from the shipping carton and examine it for evidence of damage. If any damage is found, immediately notify the transportation company that delivered the shipment. Keep the shipping carton and packing material for the transportation company to examine. Keeping these items is recommended in any case, as having them available makes shipment of MN-2000 much easier should it ever be necessary to return it to the factory for service.

Fill out the warranty registration card and mail it.

### 3.2 LOCATING

The MN-2000 will work properly in almost any location. Select a location on the operating table that will allow you to reach the control knobs easily.

### 3.3 CONNECTING

Connect the RF output of your transmitter or linear amplifier to the TRANSMITTER connector of the MN-2000, using 50 ohm coaxial cable such as RG-8/U. Cable length is not critical. Connect the coaxial line feeding the antenna to the antenna 1 or antenna 2 connectors of the MN-2000. In installations using a transceiver, or transmitter-receiver combinations, the MN-2000 should be the last item the out-going RF signal passes through before entering the feed line to the antenna. The effects of this on receiver operation will be discussed in the Operating Instructions, Section 4 of this manual.

Bond the GROUND post of the MN-2000 to the station ground with a short piece of heavy braid.

VIEWING ANGLE OPTIONS

Fig. 6

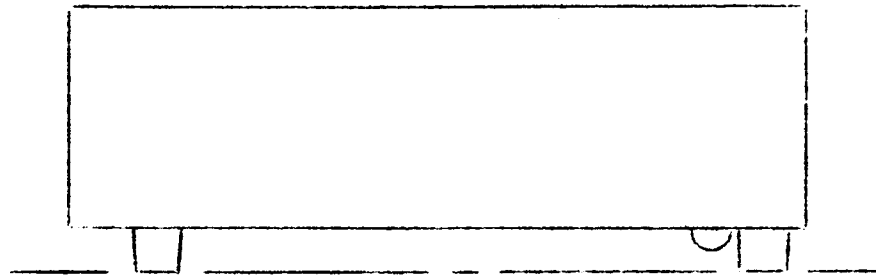

STANDARD

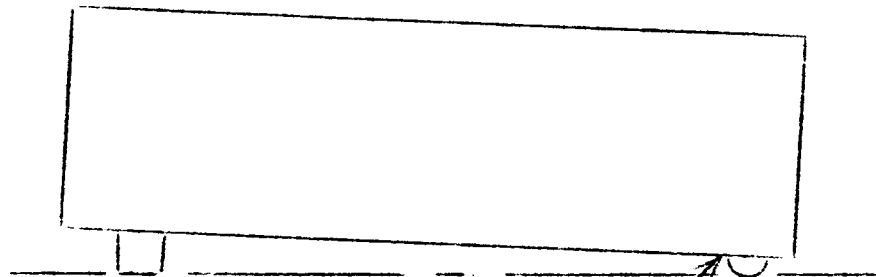

OPTION # 1

Screw mounted rear feet removed

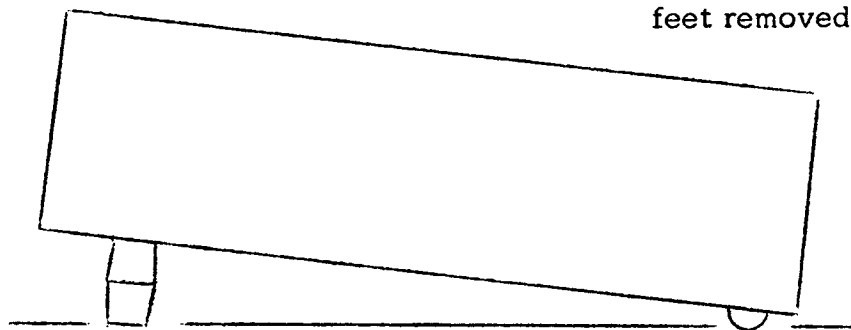

OPTION # 2

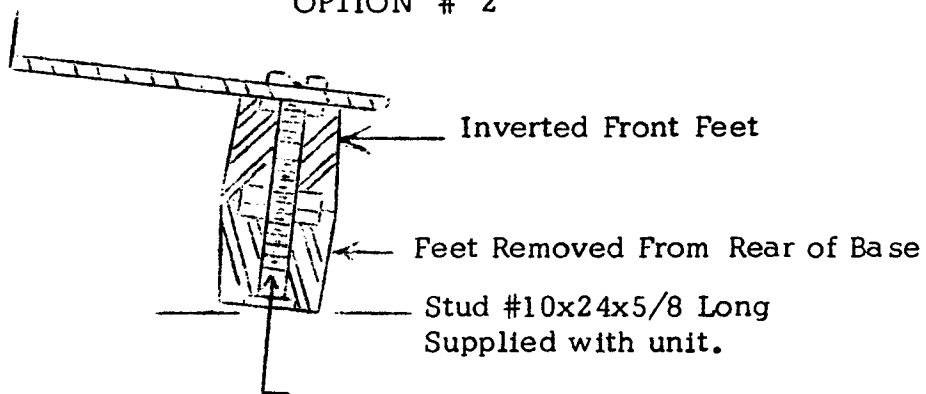

#### 4.1 CONTROLS

The controls of the MN-2000 include the bandswitch ( directly below the meter ), resistive tuning, reactive tuning, push to set-release for VSWR, forward watts-VSWR, and antenna selector switch. The functions of these controls are described below.

#### 4.2 BANDSWITCH

The primary function of the bandswitch is selection of the fixed capacitors and inductors needed for each band. It should be set to the band desired.

#### 4.3 RESISTIVE TUNING

The RESISTIVE TUNING control varies the resistive component of the MN-2000 to achieve a match with the resistive component of the antenna impedance.

#### 4.4 REACTIVE TUNING

The REACTIVE TUNING control is used to tune out the reactive component of the antenna impedance.

#### 4.5 PUSH TO SET-RELEASE FOR VSWR

This control is used to vary the sensitivity of the meter circuit, and to calibrate the meter.

#### 4.6 FORWARD WATTS-VSWR

This switch connects the proper circuitry to allow the meter to read either forward power in watts, or VSWR, as desired. In the forward position two ranges are provided, 200 and 2000 watts full scale.

#### 4.7 ANTENNA SELECTION SWITCH

The antenna selector switch selects either of two antennas to be matched by the MN-2000. In the direct 1 and direct 2 positions, the tuning network is removed and the VSWR of the antennas may be observed directly on the meter.

#### 4.8 OPERATING PROCEDURE

CAUTION: An antenna or dummy load MUST be connected to the MN-2000 before energizing the transmitter to avoid damage to the MN-2000 and the transmitter. MN-2000 tuning should be done with low transmitter power whenever possible.



Preset the operating controls:

BANDSWITCH	To desired band
RESISTIVE TUNING	To 5
REACTIVE TUNING	To 5
PUSH-RELEASE	Fully counterclockwise
FORWARD WATTS-VSWR	To VSWR
ANTENNA SELECTOR	To either match 1 or match 2 whichever antenna is desired

An alternate position is provided to connect a third antenna or dummy load. The tuning network is not connected in the alternate position.

All the following operations may be done without the use of the linear amplifier in installations using transmitter/linear combinations.

Energize transmitter, apply low power to the MN-2000, and adjust transmitter plate tuning to resonance. The VSWR meter should read upscale. Vary the RESISTIVE TUNING until the VSWR dips, then turn the REACTIVE TUNING control clockwise to bring the VSWR indication slightly upscale. Re-adjust the RESISTIVE TUNING for a dip. If this dip is lower than the first dip, you are tuning in the right direction, and should continue to alternately move the REACTIVE tuning control clockwise and tune the RESISTIVE tuning for a dip until a minimum VSWR indication is obtained.

If the second dip found reads higher on the meter than the first dip, the REACTIVE tuning control must be turned counterclockwise a short distance, and the RESISTIVE tuning adjusted for a dip. Continue alternating these adjustments until a minimum VSWR reading is reached.

If the dips found during the tuning procedure are so far downscale that it becomes difficult to tell whether a particular dip is lower or higher than the preceding one, you can increase meter sensitivity and get readings that are farther upscale by turning the PUSH-RELEASE knob clockwise. With this added sensitivity it may not be possible to dip to the meter zero, but any residual reading will represent a very small power level, probably less than 0.1 watt.

When MN-2000 has been adjusted to the lowest possible dip, it is properly tuned to present a 50 ohm resistive load to the transmitter. ( Make a note of the settings of the RESISTIVE AND REACTIVE tuning controls and the bandswitch. The next time you operate on this band, you can tune up quickly by returning the MN-2000 controls to the same settings ).

Adjust the transmitter plate tuning and loading controls as directed by the transmitter instruction book. Push in on the PUSH-RELEASE control, and rotate the knob clockwise until the meter pointer lines up with the SET mark ( full scale )

on the meter face. Release the knob. The meter is now calibrated for VSWR measurements.

#### 4.9 OFF-THE-AIR TUNING

If a 50 ohm dummy load that is capable of handling the full transmitter power output is available, it and the MN-2000 can be used to tune up with minimum interference. Connect the 50 ohm load to the ALTERNATE connector on the MN-2000, switch the MN-2000 antenna selector to ALTERNATE, connect the transmitter RF output to the MN-2000 TRANSMITTER connector and turn on the transmitter. The exciter and linear amplifier can now be tuned to match the 50 ohm dummy load. Turn off the linear amplifier and reduce the transmitter power output, without changing the transmitter loading. As little as 10 watts input to the MN-2000 is enough for tuning. Set the bandswitch to the desired band, and switch the antenna selector switch to match the correct antenna. Tune the MN-2000 for minimum VSWR and increase the power of the transmitter to the desired operating level. If the linear amplifier has a 50 ohm input it may now be switched in with no change of tuning.

#### 4.10 REFLECTED POWER

It is possible to read reflected power with the MN-2000, although the instrument was not primarily designed to do this. To read reflected power, first rotate the PUSH-RELEASE knob fully counterclockwise, and set the meter function switch to the 200 or 2000 watt scale. Increase transmitter power to the desired level ( not to exceed 1000 watts continuous ) then change the meter function switch to the VSWR setting. Push in on the PUSH-RELEASE knob and turn it clockwise until the meter indicates the same as forward power. Release the PUSH-RELEASE knob. The meter now indicates reflected power on the power scale.

#### 4.11 USE WITH TRANSCEIVERS AND T/R COMBINATIONS

Adjustment of the MN-2000 with a transceiver is done exactly as described in Paragraphs 4.7 through 4.9. Since the received signal will be passed through the MN-2000, it is necessary to tune up the MN-2000. If this is not done, the received signal will be attenuated by the MN-2000 whenever the bandswitch setting is not the same as the band being tuned. Direct position of antenna switch may be used instead of tuning up MN-2000.

#### 4.12 DIRECT OPERATION

In the direct 1 and direct 2 positions of the antenna selector switch the matching network is switched out of the circuit and the transmitter is connected directly to the antenna. In the direct position the VSWR of the antenna may be displayed on the meter with some power supplied to the MN-2000 ( as little as

20 watts is sufficient ) switch the meter to VSWR position. Depress the PUSH-RELEASE knob and rotate the sensitivity control until the meter rests at the set mark. Release the PUSH-RELEASE knob, the meter now reads VSWR directly on the VSWR scale. In all positions of the antenna selector switch the wattmeter is connected and the output of the transmitter may be observed on the meter.

#### 4.13 TUNING CURVES

A series of tuning curves, showing control settings versus load impedance, are presented on page 10 through 15 of this manual. These curves may be used to determine the approximate load impedance from the tuning control settings, and the approximate tuning control settings required on each band for a known load impedance. All points on the REACTIVE tuning curves represent load impedances ( capacitive and inductive ) with 5:1 VSWR. Points in the area enclosed by the REACTIVE tuning curves are points with a VSWR of less than 5:1. The MN-2000 can satisfactorily tune antennas with VSWR well in excess of 5:1 when the antenna impedance is primarily resistive.

#### 4.14 MAINTENANCE

The MN-2000 should be practically maintenance free, as it is a passive device. If either, or both, of the 1N295 diode rectifiers for the wattmeter are damaged, they must be replaced with the same type diodes. Substitution of other type diodes may seriously degrade the accuracy of the wattmeter. If any problems arise that cannot be corrected, either return the MN-2000 to your dealer; or write to our Service Department, describing your problem in full, including external connections, control settings, type of antenna and transmitter, etc. Do not return your MN-2000 to the factory without proper authorization.

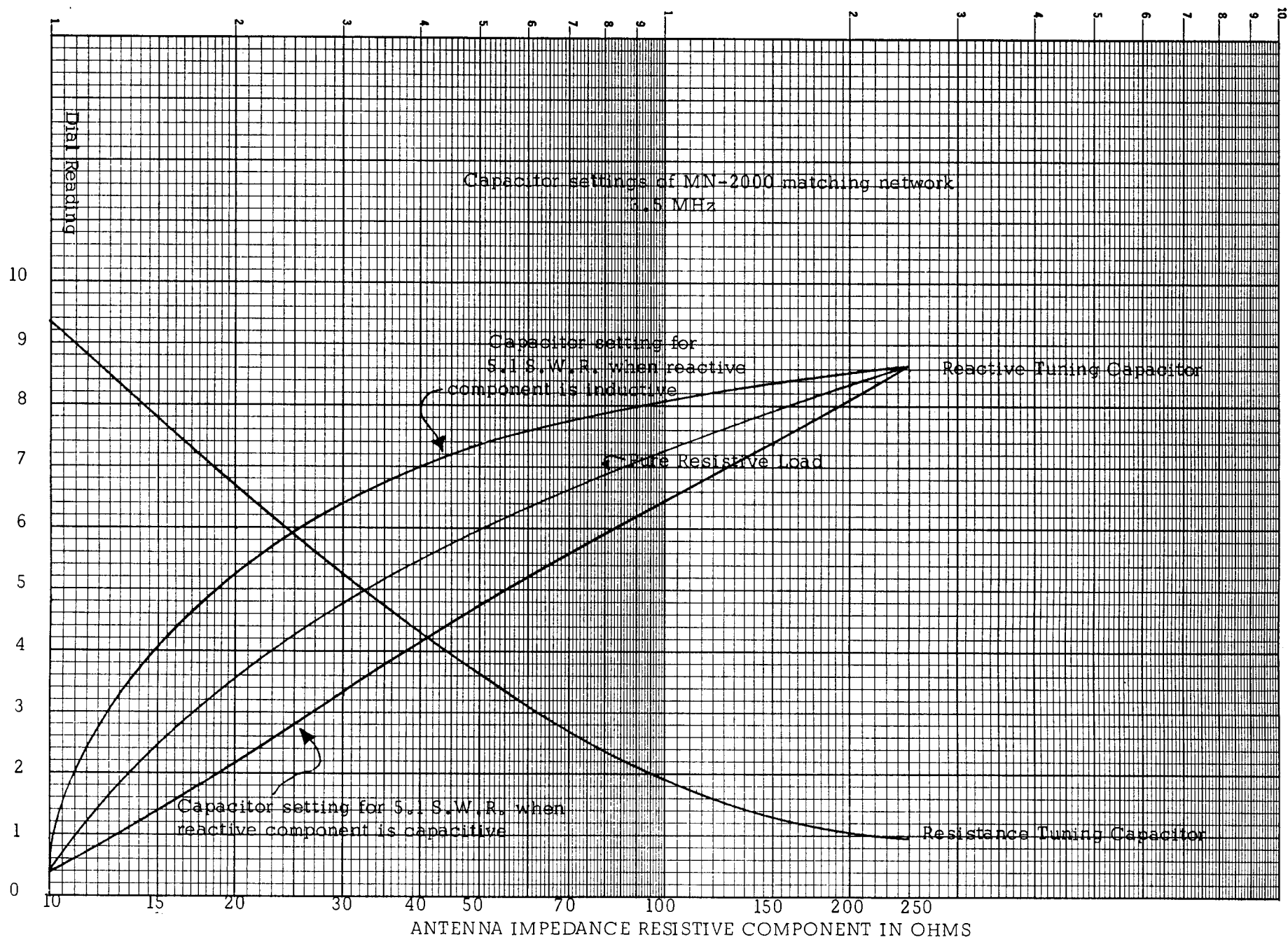

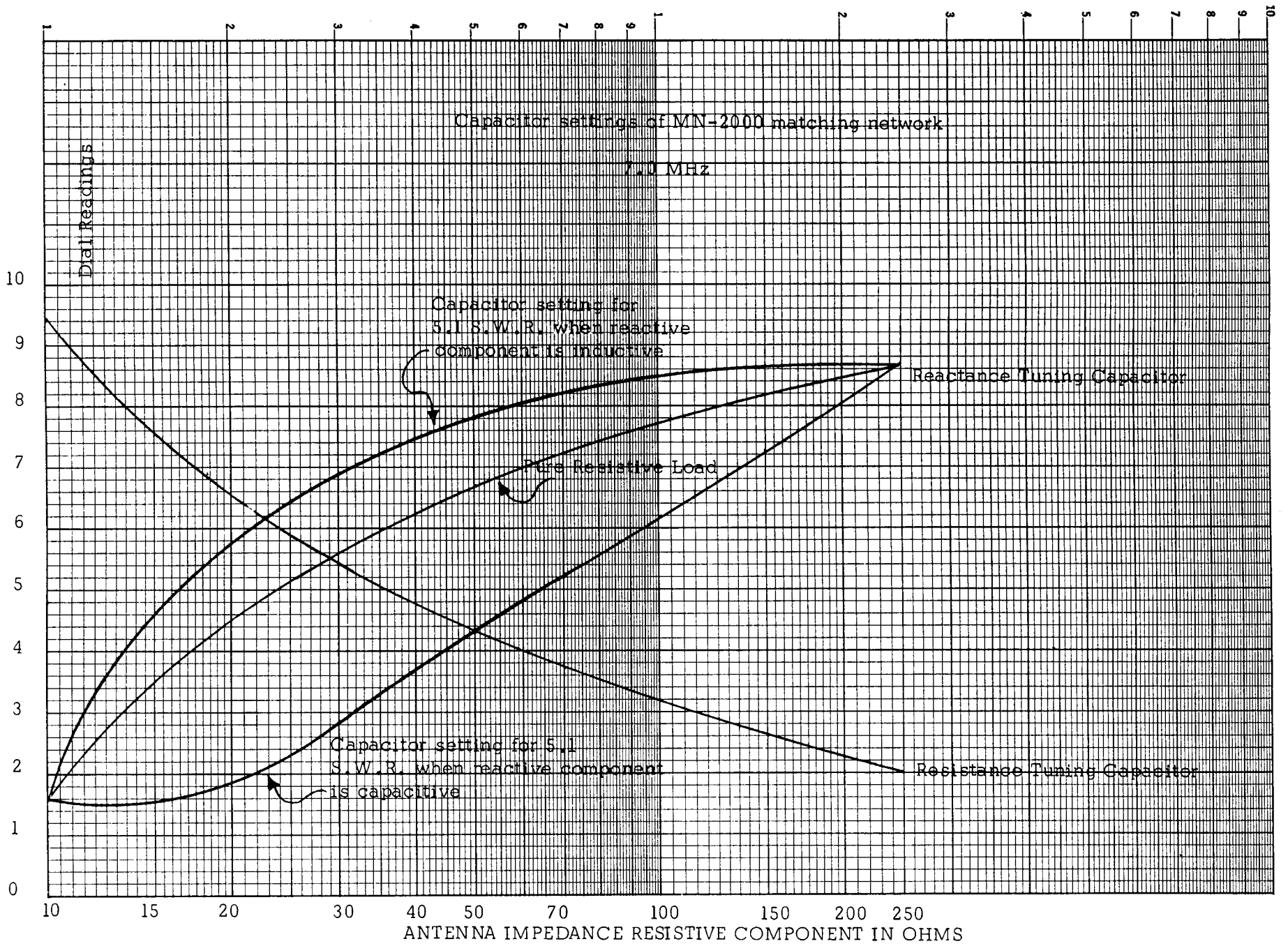

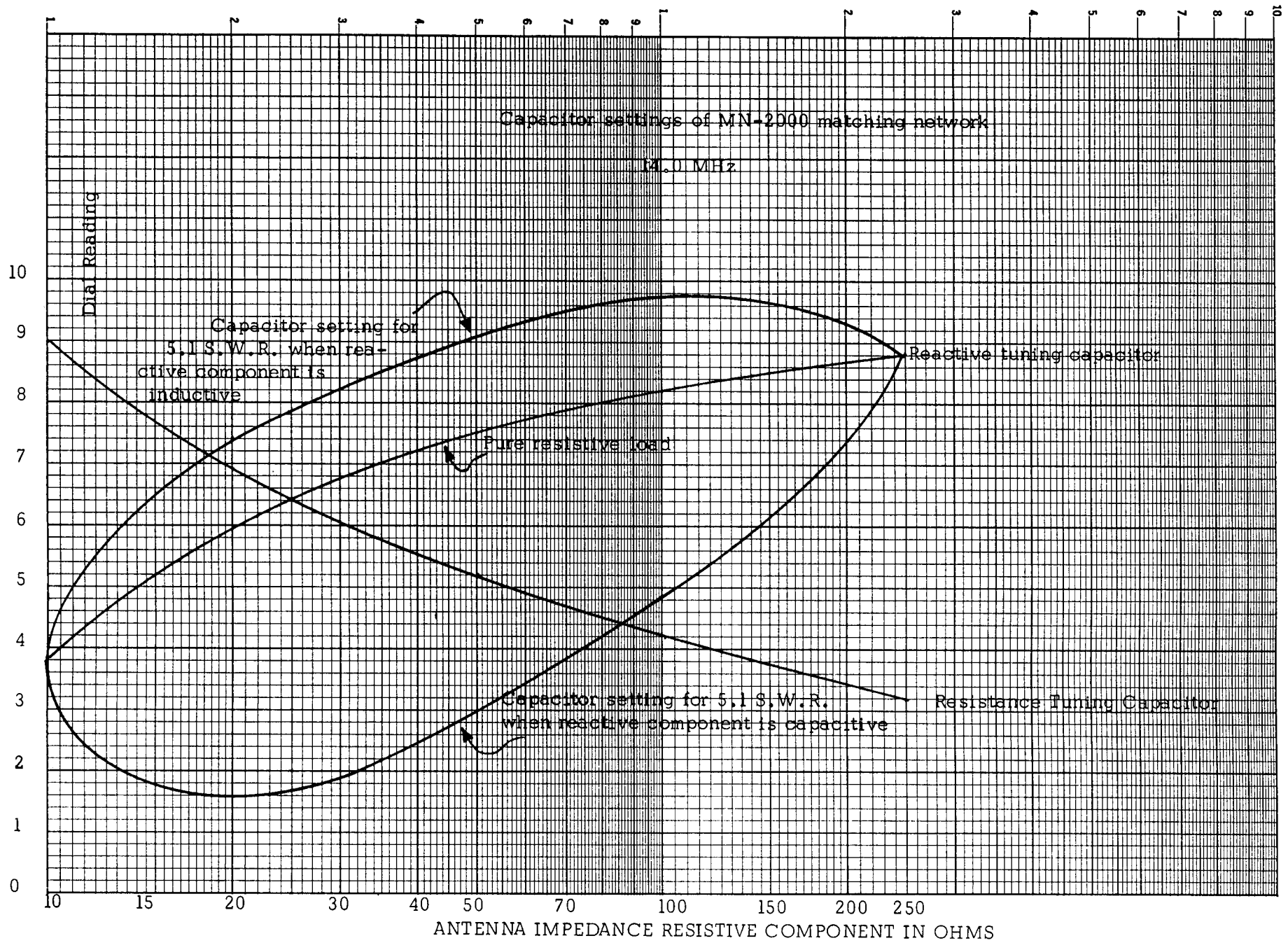

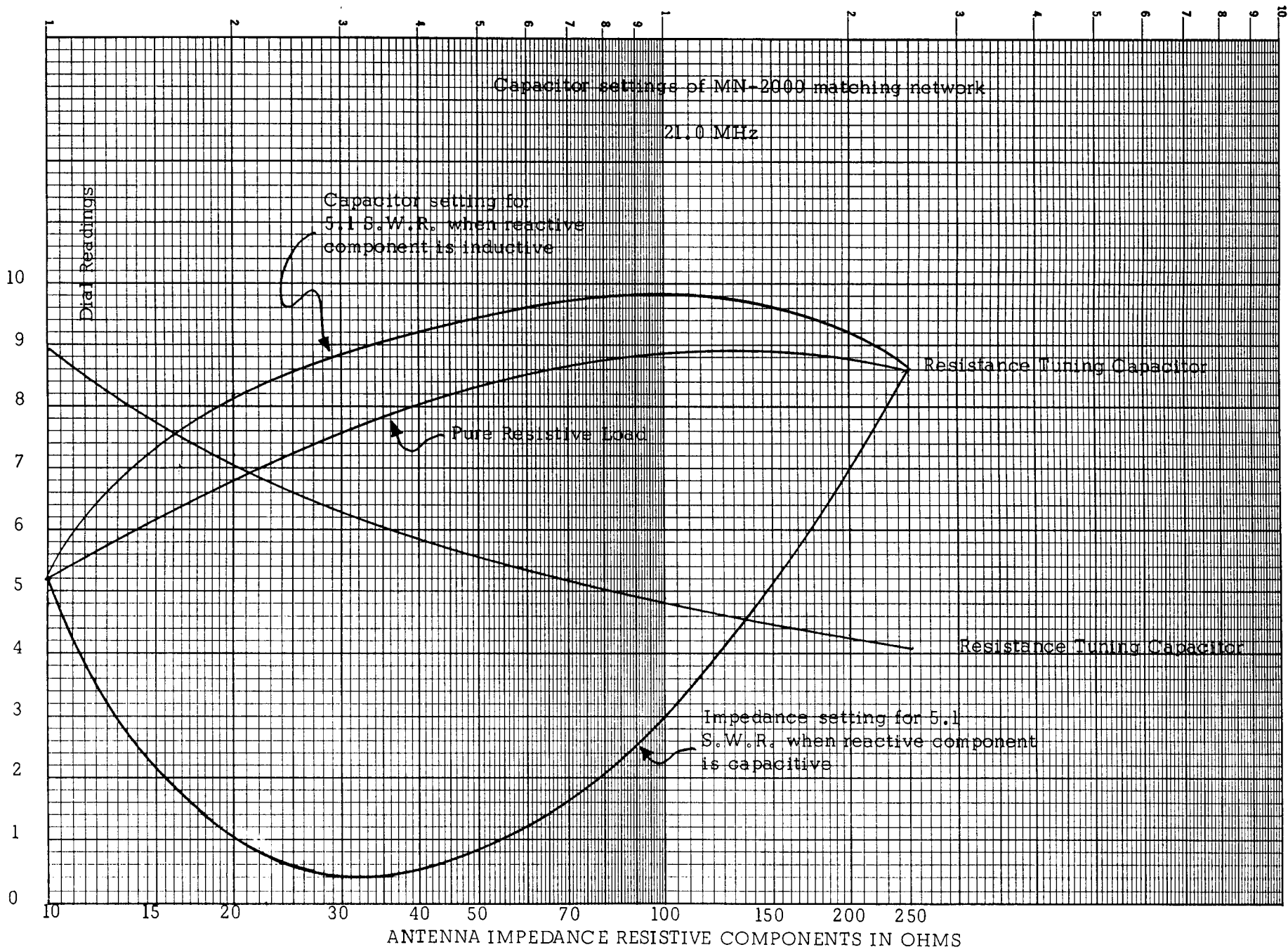

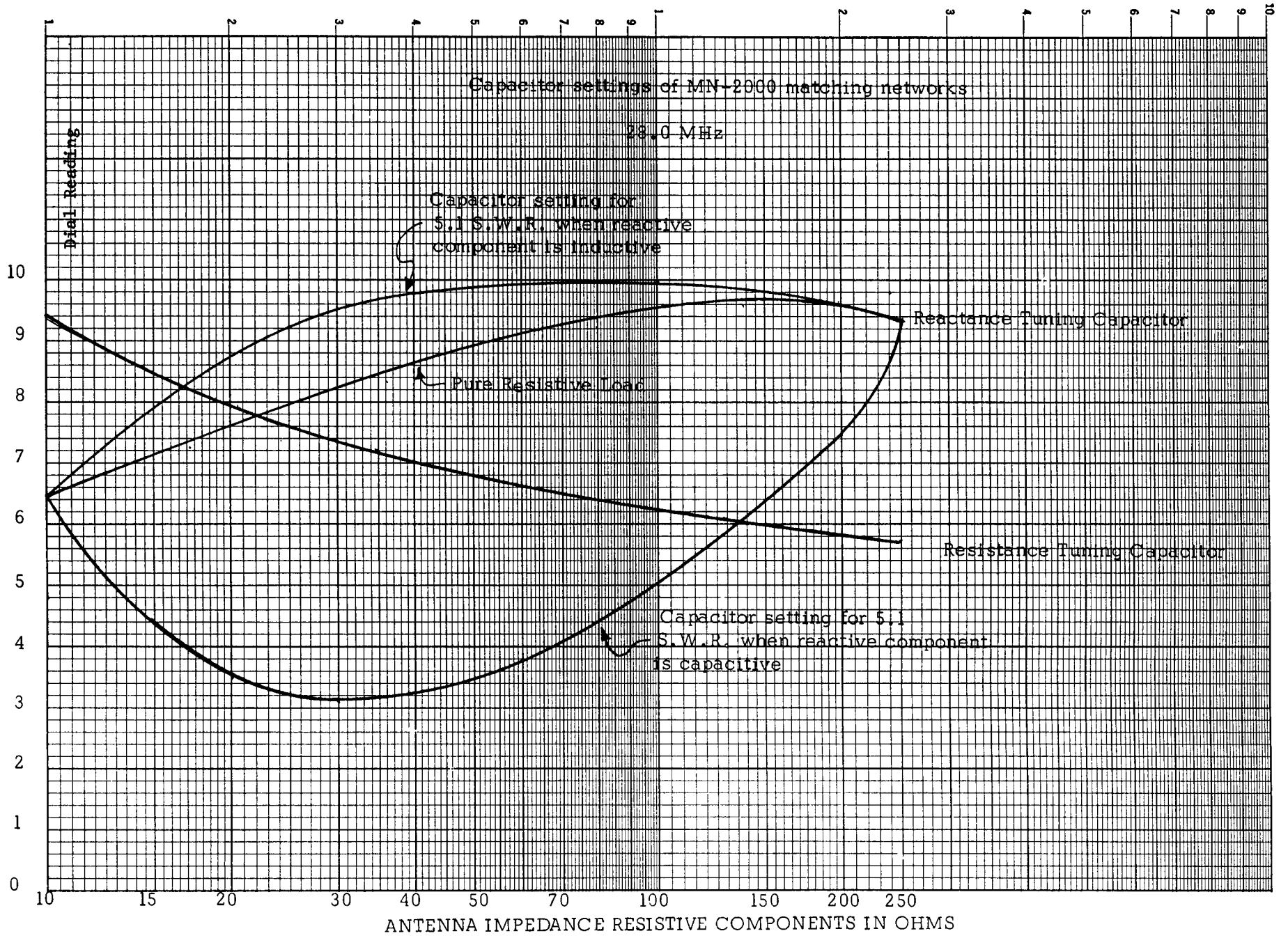



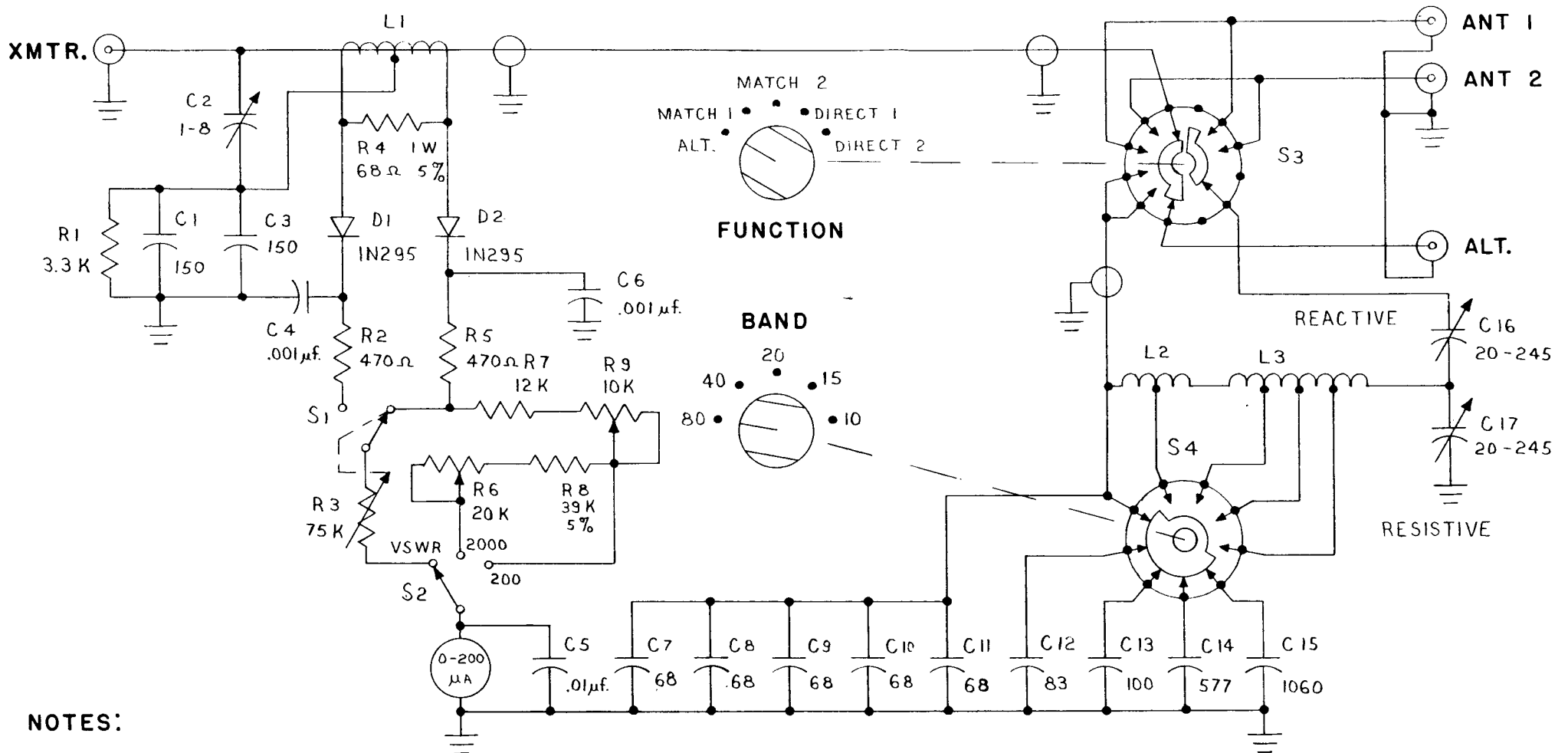

**NOTES:**

Resistors are 1/2 watt  
10%. Capacitors are in  
pf unless otherwise noted.

**SCHEMATIC DIAGRAM MODEL  
MN-2000 MATCHING NETWORK**